

TX7110

Intelligent Heat Detector Installation and Operation Manual



Product Safety

To prevent severe injury and loss of life or property, read the instruction carefully before installing the detector to ensure proper and safe operation of the system.



European Union directive

2012/19/EU (WEEE directive): Products marked with this symbol cannot be disposed of as unsorted municipal waste in the European Union. For proper recycling, return this product to your local supplier upon the purchase of equivalent new equipment, or dispose of it at designated collection points.

For more information please visit the website at www.recyclethis.info

EN54 Part 5 Compliance

TX7110 Intelligent Heat Detector complies with the requirements of EN 54-5:2017 + A1:2018



EN54 Standard Conformity Information

CE 2831 22
TANDA DEVELOPMENT PTE. LTD. 21 BUKIT BATOK CRESCENT #15-75 WCEGA TOWER SINGAPORE 658065
TX7110 2831-CPR-F2792
EN 54-5:2017 + A1:2018



Table of Content

1 Introduction 4
 1.1 Overview 4
 1.2 Feature and Benefits 4
 1.3 Technical Specification 4
2 Installation 5
 2.1 Installation Preparation 5
 2.2 Installation and Wiring 5
3 Detector Configuration 6
 3.1 Preparation 6
 3.2 Write: Addressing 6
 3.3 Set: LED On/Off 6
 3.4 Read Configuration 7
4 General Maintenance 7
5 Troubleshooting Guide 8
Appendix 1 8
 Limitation of Heat Detectors 8

1 Introduction

1.1 Overview

The TX7110 Intelligent Fixed and Rate of Rise Heat Detector is reliable for application in places where may have high dust level or smoky environments, making a normal smoke detector undesirable. The unit manufactured base on the sensitivity requirement of EN 54 part 5, European Standard. The unit is aesthetically pleasing with unobtrusive design that will complement modern building designs. The unit incorporates an intelligent processor that provides inbuilt A/D converter, and Self-Diagnosis and History log.

In the event of fire, the integral microprocessor analyses the signal according to factors such as signal strength and rate of increase, then confirms these patterns with the pre-programmed fire scenarios, heat patterns including rate of rise temperature patterns, for a faster and safer response. Once it is confirmed, the LED indicates the sensor status and parallel sending communication signal to the control panel. The TX7110 detector is compatible to the TX7004 Analogue Intelligent Fire Alarm Control Panel, produced by single manufacture T&A, to avoid addressable communication compatibility problem.

1.2 Feature and Benefits

- EN54-5 Compliance
- Using microprocessor technology with memory capacity up to 10 events
- Analogue sensor and digital addressing
- Provide real time algorithm to the control panel
- 360 degree visual indicator
- Onsite Adjustable Parameter
- Ancillary remote indicator output
- Aesthetically pleasing design

1.3 Technical Specification

• Listed	LPCB Certification
• Compliance	EN 54-5:2017 + A1:2018
• Input Voltage	24VDC [16V to 28V]
• Current Consumption Standby	0.6mA, Alarm: 4mA
• Protocol/Addressing	T&A, Value range from 1 to 254
• Heat Class Type	A1R
• Indicator	Single LED / 360 degree Visual
• Material / Colour	ABS / White Glossy finishing
• Dimension / Height	Diameter 99.7 mm / 57 mm
• Weight	127g (with Base), 72g (without Base)
• Operating Temperature	-10°C to +50°C
• Humidity	0 to 95% Relative Humidity, Non condensing

2 Installation

2.1 Installation Preparation

This detector must be installed, commissioned and maintained by a qualified or factory trained service personnel. The installation must be installed in compliance with all local codes having a jurisdiction in your area or BS 5839 Part 1 and EN54.

The TX7110 heat detector has two conditions, fixed and rate of rise temperature. When power on, both conditions are working until the sensing element satisfies on one of the condition, the detector goes to alarm. The fixed temperature has a sensing element fixed at a specific temperature, and when it reached, the detector activates. The rate of rise temperature heat detector will response to a sudden increase in temperature, this makes ideal for areas where smoke detector is unsuitable.

2.2 Installation and Wiring

1. Mount the T&A standard base on standard one [1] gang electrical back box. Do not over-tighten the screws otherwise the base will twist. Use M4 standard screws.
2. Connect the wire in terminal as shown in Figure two [2]. Verify the device number or other device parameters if desired using handheld programmer then stick on the label before attaching detector.
3. Attach the detector to the base, point the detector in the base by the mark-line and secure the detector in that position by rotating it clockwise, until it reaches the next mark line.
4. Do not remove the red plastic dust cover until the final handover is done.
5. The connecting line of remote indicator should be less than 30 meters.

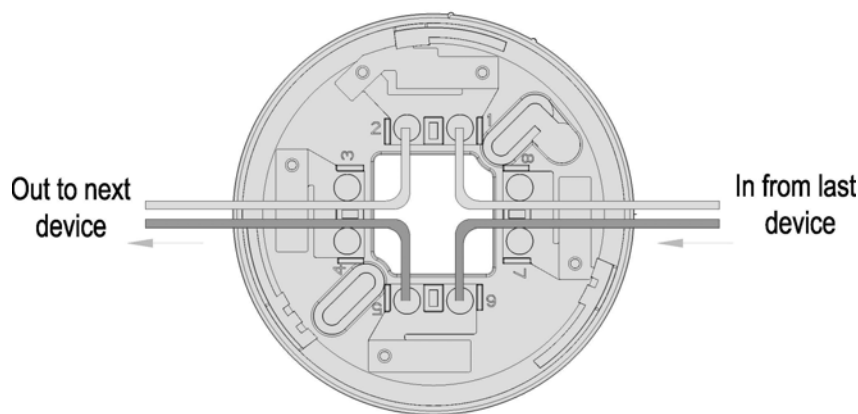

Figure 2

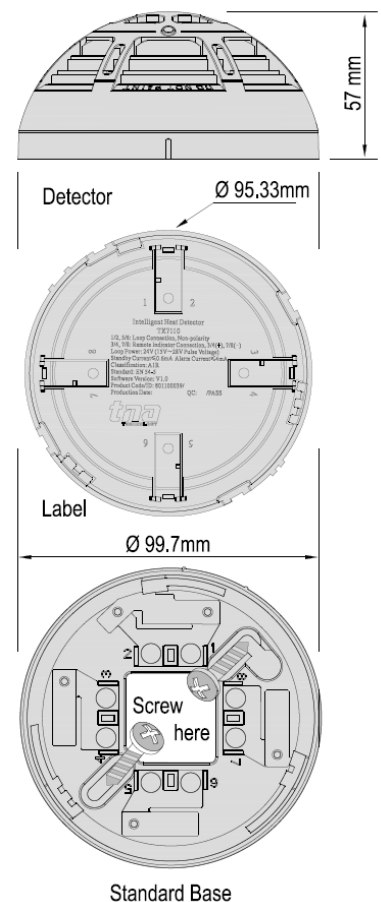

Figure 1

Terminal Description

- | | |
|---|----------------------|
| 1 | Signal In (+) |
| 2 | Signal Out (+) |
| 3 | Remote Indicator (+) |
| 4 | Remote Indicator (+) |
| 5 | Signal In (-) |
| 6 | Signal Out (-) |
| 7 | Remote Indicator (-) |
| 8 | Remote Indicator (-) |

3 Detector Configuration

3.1 Preparation

The TX7930 handheld programmer is used to configure heat detectors soft address and parameters. This tool is not included, must be purchased separately. The programmer is packed with twin 1.5V AA battery and cable, ready for usage once received.

It is mandatory for the commissioning personnel to have programmer tool enable to adjust the detector conferring to the site situation and environmental requirements.

Program a unique address number for each device according to the project layout before placing from the Terminal Base.

Warning: Disconnect the loop connection whilst connecting to the handheld programmer.

3.2 Write: Addressing

1. Connect the programming cable to 1 and 6 terminals (Figure 3). Press **"Power"** to switch on the unit.
2. Switch-on the programmer, then press button **"Write"** or number **"2"** to enter Write Address mode (Figure 4).
3. Input the desired device address value from 1 to 254, and then press **"Write"** to save the new address (Figure 5).

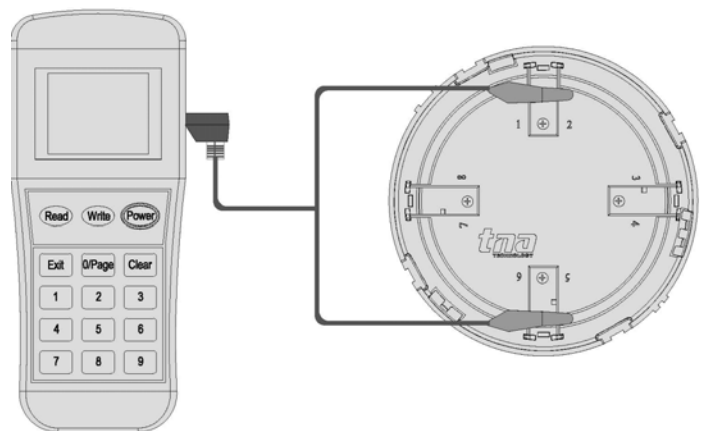

Figure 3

Note: If display **"Success"**, means the entered address is confirmed. If display **"Fail"**, means failure to program the address (Figure 6).

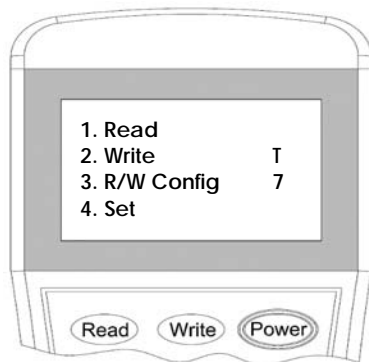

Figure 4



Figure 5



Figure 6

4. Press **"Exit"** key to go back Main Menu. Press **"Power"** key to switch-off the programmer.

3.3 Set: LED On/Off

1. The LED indicator can be turn-off if desired, the sensing ability of the detector will not disrupt even the LED is off.
2. Attach the programming cable to 1 and 6 Terminals of detector. Press **"Power"** to switch-on the unit.
3. Switch-on the programmer, then press button **"4"** to enter to Setting mode (Figure 7).
4. Input the **"1"** then press **"Write"** to change the setting (Figure 8) and LED will turn-off. To resume the default setting, press **"Clear"** and then press **"Write"**.

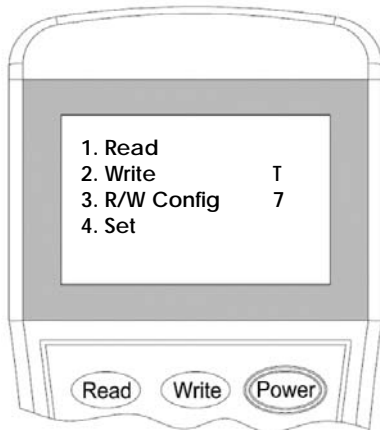

Figure 7

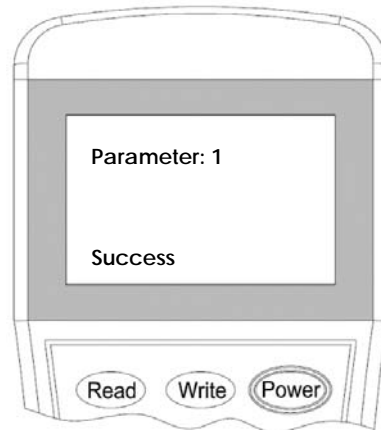

Figure 8

Parameter Description	
0-	LED On (Default)
1-	LED Off

5. Press **“Exit”** key to go back Main Menu. Press **“Power”** to switch off the programmer.

3.4 Read Configuration

1. Attach the programming cable to 1 and 6 terminals of detector. Press **“Power”** to switch on the unit.
2. Switch-on the programmer, then press button **“Read”** or **“1”** to enter to Read mode (Figure 9). The programmer will display the configuration after few seconds. (Figure 10).

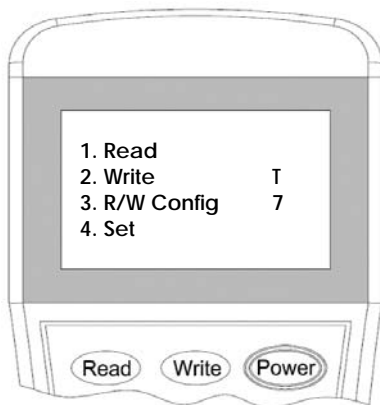

Figure 9



Figure 10

Read Description	
Address:	Unique number assigned
Category:	Detector type
ID:	Detector serial number

3. Press **“Exit”** key to go back Main Menu. Press **“Power”** key to switch off the programmer.

4 General Maintenance

1. Inform the suitable personnel before conducting the maintenance.
2. Disable the detector on the control panel to prevent false alarm.
3. Do not attempt to adjust or modify the detector, it may affect the ability of the detector to respond to a fire condition and will void the manufacturer’s warranty.
4. Use a damp cloth to clean the detector. Do not use cleaning chemicals that may leave residue on the electronic parts.
5. Notify again proper personnel after conducting the maintenance and make sure to enable the detector and confirm if up and running.
6. Perform the maintenance on semi-annually or quarterly depending on the site conditions.

5 Troubleshooting Guide

What you notice	What it means	What to do
Address not enrolling	The wiring is loose The address is duplicate	Conduct maintenance Re-Commission the detector
Unable to commission	The damage the electronic circuit	Replace the detector
Keep Indicating Fire signal	The selected type of sensing element is not matching the room temperature condition	Re-Program the detector

Appendix 1

Limitation of Heat Detectors

The heat detector cannot last forever. In order to keep the detector working in good condition, please maintain the equipment continuously according to recommendations from manufacturers and relative nation codes and laws. Take specific maintenance measures on the basis of different environments.

The heat detector contains electronic parts. Even though it is made to last for a long period of time, any of these parts could fail at any time. Therefore, test your heat detector at least every half-year according to national codes or laws. Any heat detectors, fire alarm devices or any other components of the system must be repaired and/or replaced immediately as they fail.