

TX7300

Addressable Sounder Strobe Installation and Operation Manual



Product Safety

To prevent severe injury and loss of life or property, read the instruction carefully before installing the Sounder Strobe to ensure proper and safe operation of the system.



European Union directive

2012/19/EU (WEEE directive): Products marked with this symbol cannot be disposed of as unsorted municipal waste in the European Union. For proper recycling, return this product to your local supplier upon the purchase of equivalent new equipment, or dispose of it at designated collection points.



For more information please visit the website at www.recyclethis.info

EN54 Part 3 Compliance

TX7300 Addressable Sounder Strobe complies with the requirements of EN 54-3:2001 + A1:2002 + A2:2006、EN 54-3:2014 + A1:2019



EN54 Standard Conformity Information

CE 2831 20
TANDA DEVELOPMENT PTE. LTD. 21 BUKIT BATOK CRESCENT #15-75 WCEGA TOWER SINGAPORE 658065
TX7300 2831-CPR-F2793
EN 54-3:2014 + A1:2019



EN 54-3
1330d/01

Table of Content

1 Introduction 4
 1.1 Overview 4
 1.2 Feature and Benefits..... 4
 1.3 Technical Specification 4
2 Installation 5
 2.1 Installation Preparation 5
 2.2 Installation and Wiring 5
3 Sounder Strobe Configuration 6
 3.1 Preparation..... 6
 3.2 Addressing 6
 3.3 Single and Dual Address Mode 7
 3.4 Typical and Saving Mode 8
 3.5 Sounder Strobe Type..... 8
 3.6 Tones Selection..... 9
 3.7 Read Configuration 10
4 General Maintenance 11
5 Troubleshooting Guide 11
Appendix 1 11
 Operational Performance Data for LPCB Approved Tones..... 11
 Limitation of Sounder Strobe Device 13

1 Introduction

1.1 Overview

The TX7300 Addressable Sounder Strobe is alarm warning device used to notify persons in the vicinity of the occurrence fire emergency in order the person to take appropriate measures. The unit adopt multi-application device starting from the types, parameters and wiring layout in single unit. The TX7300 can change into different alarm warning types such as sounder-strobe type, sounder type or strobe type using programming tool. In addition, parameters can be configured according to the requirement which include alarm tone from 17 different tones, single address or dual address mode and also setting of power mode to low current consumption in a simple programming.

The unit manufactured base on the requirement of EN 54 part 3, European Standard. The unit is aesthetically pleasing with unobtrusive design that will complement modern building designs and its plug-in type assembles make installation and maintenance more convenient to the installer. The unit is compatible to the TX7004 Analogue Intelligent Fire Alarm Control Panel, produced by single manufacture T&A, to avoid addressable communication compatibility problem.

1.2 Feature and Benefits

- EN54-3 Compliance
- Built-in MCU processor and digital addressing
- 17 tones Programmable sound output
- Programmable types such as Sounder-Strobe, Sounder or Strobe alone
- Programmable Evacuate or Pre-alarm/Evacuate signal
- Low and normal consumption mode
- One or Two addresses mode
- 10 Highlights LED status cluster
- Onsite Adjustable Parameters
- Loop or external power input
- Aesthetically pleasing design
- Universal mounting with fix base for simple installation

1.3 Technical Specification

- | | |
|--|---|
| • Listed | LPCB Certification |
| • Compliance | EN 54-3 |
| • Input Voltage | Loop Power: 24VDC [18V to 27.5V]
External PSU: 24 VDC [20V to 27.5V] |
| • Typical Current
[Loop and External PSU] | Loop: Standby 0.6mA, Alarm: 1.5mA
External PSU: Standby 0.6mA, Alarm: 15mA |
| • Saving Current
[Loop powered] | Standby 1.2mA, Alarm: 9mA |
| • Protocol/Addressing | T&A, Value range from 1 to 254 |
| • Address Sequence | Single Address: Evacuate tone
Dual Address: 1 st Alert Tone / 2 nd Evacuate tone |
| • Strobe Light | 10 Highlights LED |
| • Material / Colour | ABS / RED Glossy finishing |
| • Dimension / Height | Diameter 110 mm / 39.6 (with Base) |
| • Weight | 176g (with Base), 110g (Without Base) |
| • Class | Type A, Indoors |
| • Operating Temperature | -10°C to +50°C |
| • Ingress Protection Rating | IP21 |
| • Humidity | 0 to 95% Relative Humidity, Non condensing |

2 Installation

2.1 Installation Preparation

This alarm warning device must be installed, commissioned and maintained by a qualified or factory trained service personnel. The installation must be installed in compliance with all local codes having a jurisdiction in your area or BS 5839 Part 1 and EN54.

2.2 Installation and Wiring

1. Mount the sounder base on standard one [1] gang electrical back box. Follow the arrow mark for the correct position. Do not over-tighten the screws otherwise the base will twist. Use M4 standard screws.
2. Connect the wire in terminal as shown in Figure [2&3]. Verify the device number or other device parameters if desired using handheld programmer then stick on the label before attaching sounder-strobe. The sticker labels are available on the control panel.
3. Attach the sounder to the base, point the sounder in the base by the mark-line and secure the sounder in that position by rotating it clockwise, until it reaches the next mark line.

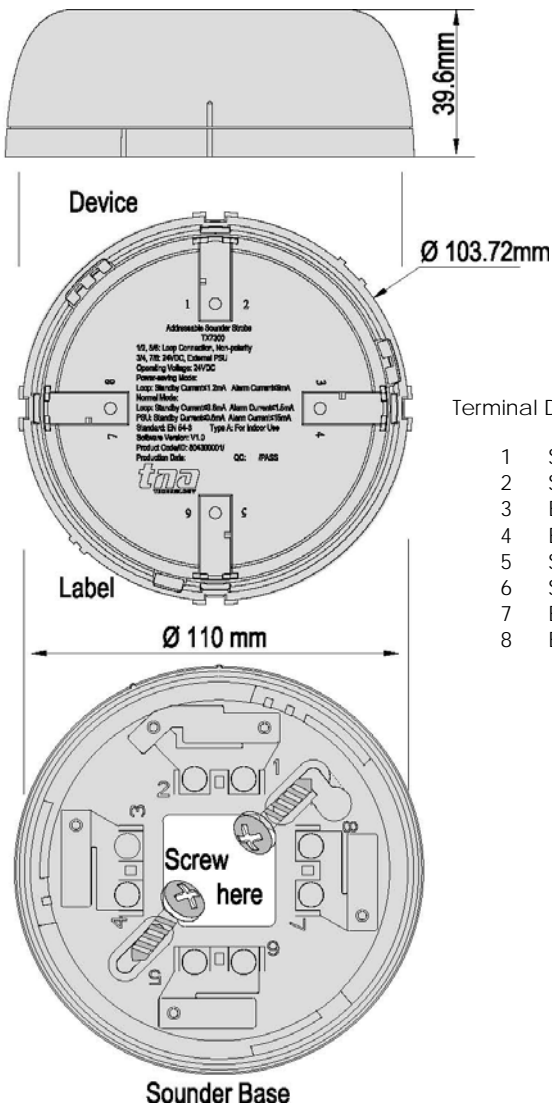

Figure 1

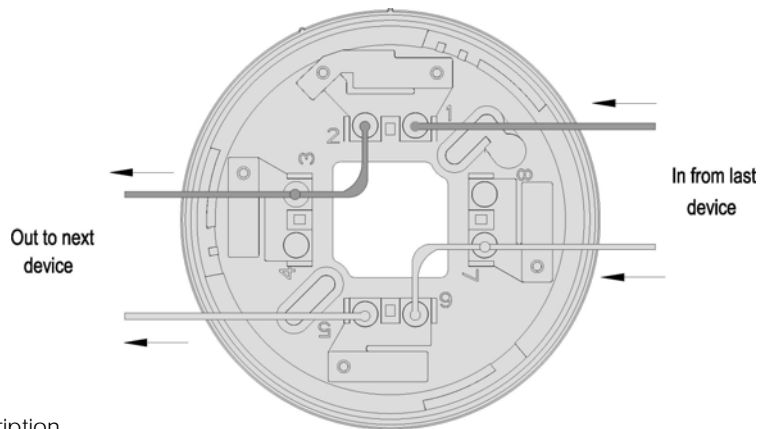

Figure 2: Loop Powered

Terminal Description

- 1 Signal In (+)
- 2 Signal Out (+)
- 3 External PSU In (+) Optional
- 4 External PSU Out (+) Optional
- 5 Signal In (-)
- 6 Signal Out (-)
- 7 External PSU In (-) Optional
- 8 External PSU Out (-) Optional

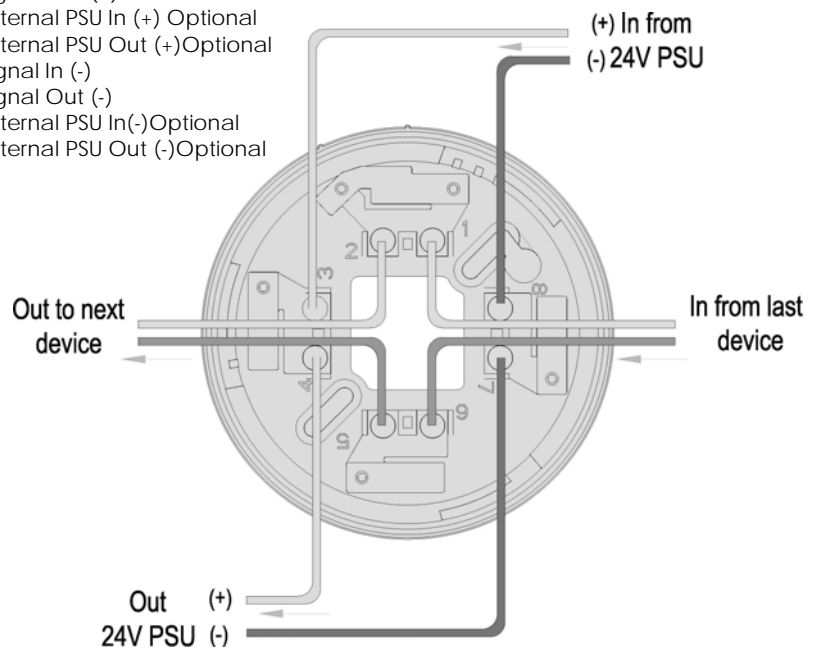

Figure 3: With External Supply

3 Sounder Strobe Configuration

3.1 Preparation

The TX7930 handheld programmer is used to configure sounder strobe soft address and parameters. This tools are not included, must be purchased separately. The programmer is packed with twin 1.5V AA battery and cable, ready for usage once received.

It is mandatory for the commissioning personnel to have programmer tool in order to adjust the sounder strobe conferring to the site situation and environmental requirements.

Program a unique address number for each device according to the project layout before placing from the Terminal Base.

Warning: Disconnect the loop connection whilst connecting to the handheld programmer.

3.2 Addressing

1. Connect the programming cable to Z1 and Z2 terminals (Figure 4). Press **"Power"** to switch on the unit.
2. Switch-on the programmer, then press button **"Write"** or number **"2"** to enter Write Address mode (Figure 5).
3. Input the desire device address value from 1 to 254 and then press **"Write"** to save the new address (Figure 6).

Note: If display **"Success"**, means the entered address is confirmed. If display **"Fail"**, means failure to program the address (Figure 7).

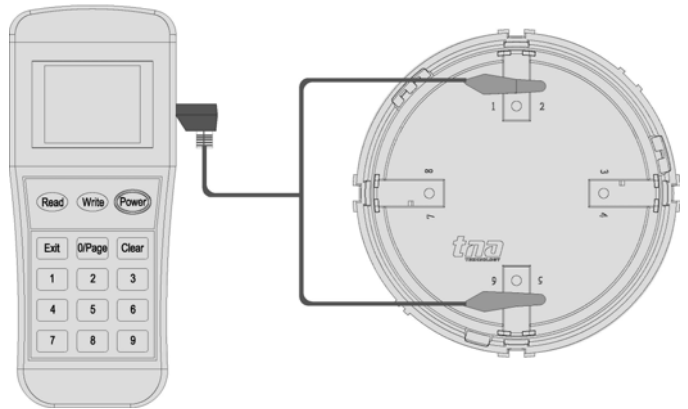

Figure 4

Press **"Exit"** key to go back Main Menu. Press **"Power"** key to switch-off the programmer.

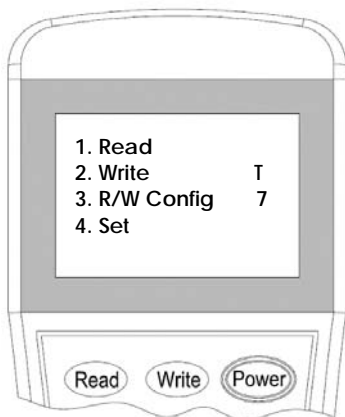

Figure 5



Figure 6



Figure 7

3.3 Single and Dual Address Mode

Single address is commonly used to program immediate Evacuate tone while the dual address used for programming Pre-alarm and Evacuate tones respectively in a given period of time.

In Single Address Mode

When in action (Evacuation stage), the sounders will produce visible signal of 1.4 flashes per second at $1\pm 20\%$ Hz frequency and simultaneously audible signal according to the pre-defined tone (Table 1- Tone 14 is the default tone) and will stop if the panel is reset.

In Dual Address Mode

When In action the **1st Address sounder** (Pre-alarm Stage), will produce visible signal of 0.7 flashes per second at $1\pm 20\%$ Hz frequency and simultaneously audible signal according to the pre-defined tone (Table 1- Tone 17 is the default tone). This will run continuously according to the pre-defined time unless the panel is being reset before.

When the delay time is over the 1st address sounder will stop then immediately, the **2nd address sounder** (Evacuate Stage) will produce visible signal of 1.4 flashes per second at $1\pm 20\%$ Hz frequency with simultaneously audible signal according to the pre-defined tone (Table 1- Tone 14 is the default tone) and will stop if the panel is reset.

1. Attach the programming cable to 1 and 6 Terminals of sounder. Press **"Power"** to switch-on the unit.
2. Switch-on the programmer, then press button **"3"** to enter to **Configuration mode** (Figure 8).
3. Input the **"1"** for **Single** Address mode or **"2"** for Dual Address mode then press **"Write"** to change the setting into the desire mode (Figure 9).

Note: If display **"Success"**, means the entered mode is confirmed. If display **"Fail"**, means failure to program the mode.

In Dual address mode, the sounder will generate the unique next higher number for the second address for example: In single address mode the address number is 15, when change to dual address mode the address numbers will now be 15 and 16.

Warning: Dual address mode may cause Duplicate address fault on the panel and may affect the operation of the next device with conflicted address number if not carefully arrange the loop addressing.

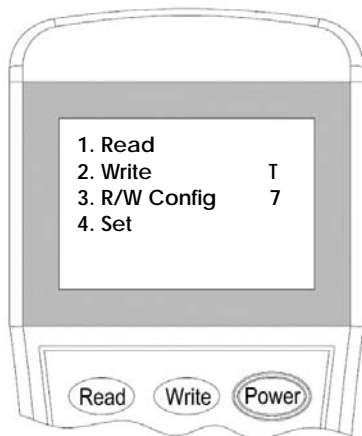

Figure 8

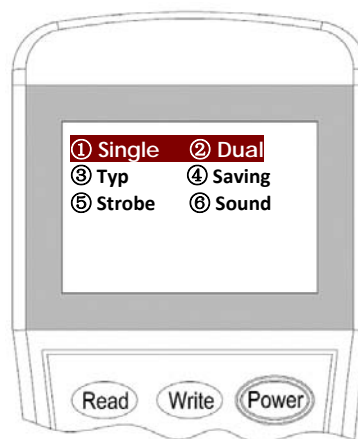

Figure 9

Configure Description	
① Single	[Default]
② Dual	

4. Press **"Exit"** key to go back Main Menu. Press **"Power"** to switch off the programmer.

3.4 Typical and Saving Mode

When Sounder-Strobe is configured to Saving Mode the recommended wiring is loop powered [Figure 2] within the limit of 20 units per loop and subject to the total calculated current load in particular loop. If Sounder Strobe is configured to Typical Mode, it requires external power supply [Figure 3] installer should consider additional power cable.

1. Attach the programming cable to 1 and 6 Terminals of sounder. Press **"Power"** to switch-on the unit.
2. Switch-on the programmer, then press button **"3"** to enter to **Configuration mode** (Figure 10).
3. Input the **"3"** for **Typical** mode or **"4"** for **Saving** mode then press **"Write"** to change the setting into the desire mode (Figure 11).

Note: If display **"Success"**, means the entered mode is confirmed. If display **"Fail"**, means failure to program the mode.

Warning: Under saving mode loop powered up to 20 sounder strobe maximum per loop is the recommended.

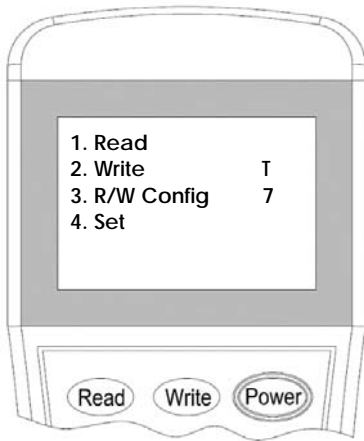

Figure 10

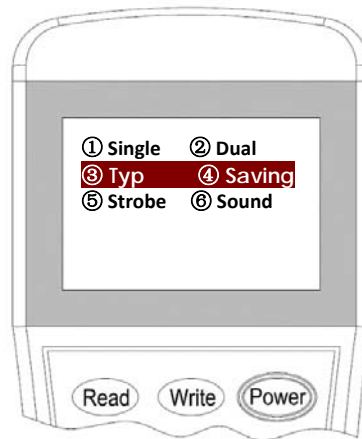

Figure 11

Read Description

- ③ **Typ:** Typical mode, the sounder device consume 15mA [Default]
- ④ **Saving:** Low current consumption at 9mA

4. Press **"Exit"** key to go back Main Menu. Press **"Power"** key to switch off the programmer.

3.5 Sounder Strobe Type

1. Attach the programming cable to 1 and 6 Terminals of sounder. Press **"Power"** to switch-on the unit.
2. Switch-on the programmer, then press button **"3"** to enter to **Configuration mode** (Figure 12).
3. Input the **"5"** for **Strobe** type or **"6"** for **Sounder** type, then press **"Write"** to change the setting into the desire mode (Figure 13).

Note: If display **"Success"**, means the entered type is confirmed. If display **"Fail"**, means failure to program the type.

4. Press **"Exit"** key to go back Main Menu. Press **"Power"** key to switch off the programmer.

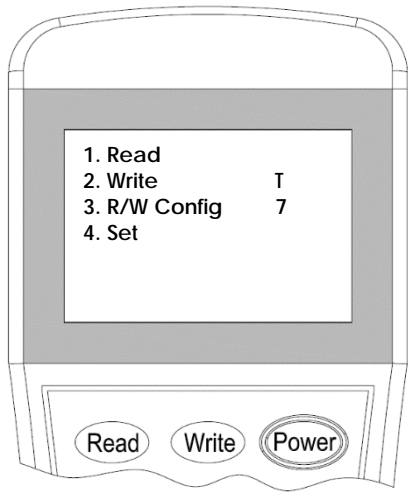

Figure 12

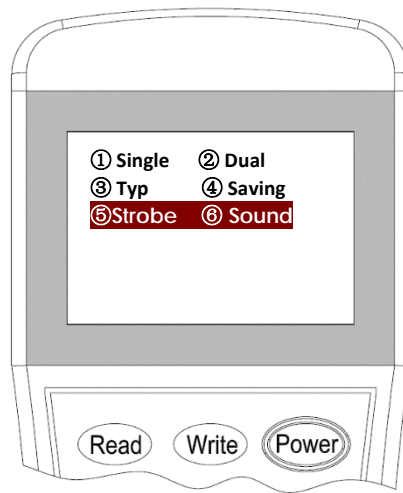

Figure 13

Read Description

⑤ **Strobe:** Visible signal only
 ⑥ **Sound:** Audible signal only
Note: Select 5 and 6 for both visible and audible signal.
 [Default 5 and 6]

3.6 Tones Selection

The Tones can be change according to the project requirement

Parameter	Tone Code	dB(A) Output (high)	dB(A) Output (low)	Description
1	01	98.9	95.7	970Hz
2	02	100.9	96.6	800Hz / 970Hz @ 2Hz
3	03	102.9	99.3	800Hz -970Hz @1Hz
4	04	99.7	97.4	970Hz 1s off / 1s on
5	05	101.3	98.7	970Hz, 0.5s / 630Hz, 0.5s
6	06	102.7	98.8	500Hz - 1200Hz×3, 3.5s on / 0.5s off
7	07	106.6	101.4	2850Hz, 0.5s on / 0.5s off×3 / 1.5s off
8	08	106.1	102.3	2850Hz 0.4s on, 0.3s off
9	09	99.7	96.6	550Hz, 0.7s / 1000Hz, 0.33s
10	10	105.7	100.8	1500Hz -2700Hz @ 3Hz
11	11	102.3	97.0	2400Hz
12	12	102.4	97.0	500Hz -1200Hz @ 0.33Hz
13	13	104.4	100.6	2400Hz -2900Hz @ 9Hz
14	14	105.7	102.0	2400Hz -2900Hz @ 3Hz [Default]
15	15	102.0	99.2	800Hz-970Hz @ 3Hz
16	16	102.1	98.8	500Hz-1200Hz, 3.75s / 0.25s off
17	17	101.3	98.7	800Hz 1s off / 1s on [Pre-alarm]

Table 1

1. Attach the programming cable to 1 and 6 Terminals of sounder strobe. Press **"Power"** to switch-on the unit.
2. Switch-on the programmer, then press button **"4"** to enter to **Setting** mode (Figure 14). The programmer will display the actual configuration after few seconds.
Input the desire Tone (Table 1) then press **"Write"** to change the setting (Figure 15).
Note: If display **"Success"**, means the entered tone is confirmed (Figure 16). If display **"Fail"**, means failure to program the tone. (Figure16) Tone 14, Tone 16 and Tone 17 are recognized by LPCB.
3. Press **"Exit"** key to go back Main Menu. Press **"Power"** to switch off the programmer.

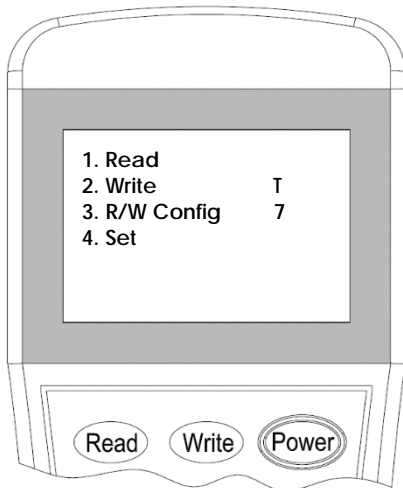

Figure 14

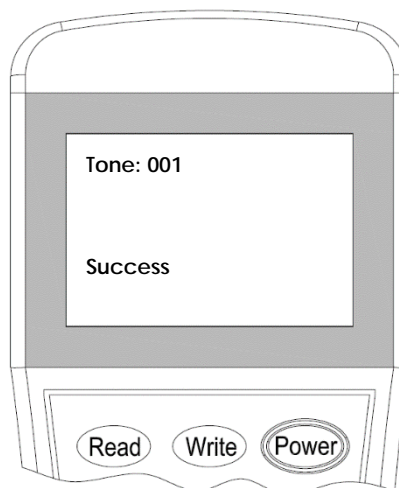

Figure 15

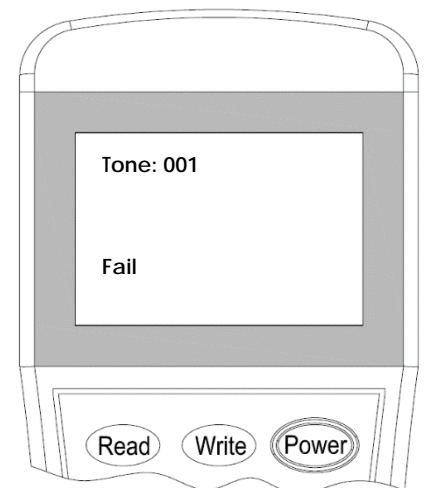

Figure 16

3.7 Read Configuration

1. Attach the programming cable to 1 and 6 terminals of sounder strobe. Press **"Power"** to switch on the unit.
2. Switch-on the programmer, then press button **"Read"** or **"1"** to enter to **Read** mode (Figure 17). The programmer will display the configuration after few seconds. (Figure 18).

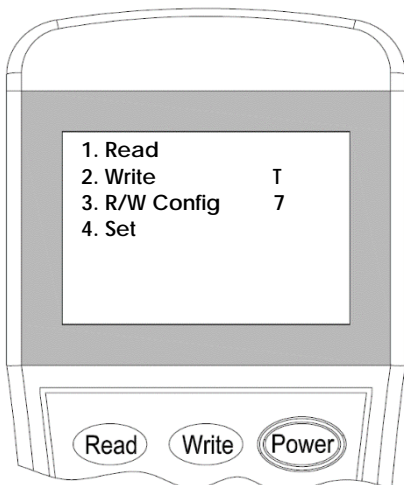

Figure 17

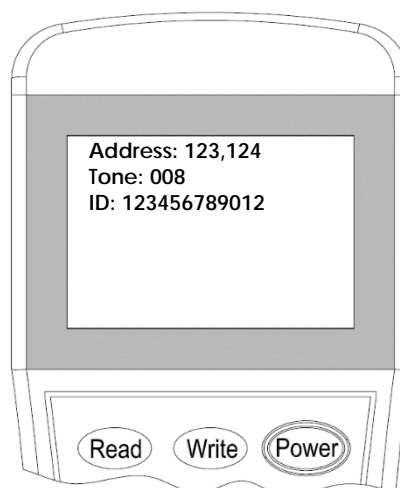

Figure 18

Read Description

Address: Unique number assigned

Note: Single address displays one address while dual addresses display two addresses

Tone: selected audible tone

ID: Device serial number

4 General Maintenance

1. Inform the suitable personnel before conducting the maintenance.
2. Disable the alarm warning device on the control panel to prevent false alarm.
3. Do not attempt to repair the circuitry of the alarm warning device, it may affect the operation to respond to a fire condition and will void the manufacturer's warranty.
4. Use a damp cloth to clean the surface.
5. Notify again proper personnel after conducting the maintenance and make sure to enable the alarm warning device and confirm if up and running.
6. Perform the maintenance on semi-annually or depending on the site conditions.

5 Troubleshooting Guide

What you notice	What it means	What to do
Address not enrolling	The wiring is loose The address is duplicate	Conduct maintenance Re-Commission the device
Unable to commission	The damage the electronic circuit	Replace the device

Appendix 1

Operational Performance Data for LPCB Approved Tones

1. Tone 14 – Volume dB(A)

Angle	Typical Mode dB(A)				Saving Mode dB(A)			
	Horizontal Plane		Vertical Plane		Horizontal Plane		Vertical Plane	
	Max27.5V	Min 20V	Max27.5V	Min 20V	Max27.5V	Min 18V	Max27.5V	Min 18V
15°	92.1	87.8	95.8	91.2	84.8	86.6	83.9	84.1
45°	93.1	88.6	96.7	91.7	84.8	83.6	89.0	88.6
75°	96.5	92.7	101.1	97.1	88.1	89.2	90.8	89.2
105°	94.5	90.2	101.3	96.1	86.2	84.8	91.2	90.1
135°	91.7	86.9	99.4	94.6	84.8	82.2	84.9	84.2
165°	89.6	84.9	97.8	93.3	83.5	84.1	84.7	84.0

Table 2

2. Tone 16 – Volume dB(A)

Angle	Typical Mode dB(A)				Saving Mode dB(A)			
	Horizontal Plane		Vertical Plane		Horizontal Plane		Vertical Plane	
	Max27.5V	Min 20V	Max27.5V	Min 20V	Max27.5V	Min 18V	Max27.5V	Min 18V
15°	89.4	84.8	89.6	85.3	83.4	80.0	83.8	80.7
45°	89.8	85.6	94.0	90.0	84.8	82.0	87.3	84.3
75°	91.2	86.8	95.6	91.7	86.8	84.0	88.0	85.3
105°	91.7	87.3	96.7	92.4	83.9	81.6	85.0	82.1
135°	90.0	86.0	90.5	86.2	83.4	79.9	87.9	85.5
165°	86.7	82.9	90.9	86.6	80.4	77.6	83.4	80.5

Table 3

3. Tone 17 – Volume dB(A)

Angle	Typical Mode dB(A)				Saving Mode dB(A)			
	Horizontal Plane		Vertical Plane		Horizontal Plane		Vertical Plane	
	Max27.5V	Min 20V	Max27.5V	Min 20V	Max27.5V	Min 18V	Max27.5V	Min 18V
15°	87.3	85.1	89.3	98.0	76.7	76.1	76.1	77.3
45°	87.3	83.9	86.7	84.4	75.4	76.8	81.0	81.2
75°	84.2	81.1	94.3	90.9	81.9	83.7	81.4	82.8
105°	84.1	82.4	90.9	87.7	79.5	81.2	79.4	80.2
135°	89.7	87.6	87.5	85.3	79.7	82.0	85.2	86.2
165°	89.4	87.2	91.2	88.9	80.8	82.3	76.6	77.2

Table 4

Limitation of Sounder Strobe Device

The alarm warning device cannot last forever. In order to keep the alarm warning device working in good condition, please maintain the equipment continuously according to recommendations from manufacturers and relative nation codes and laws. Take specific maintenance measures on the basis of different environments.

This alarm warning device contains electronic parts. Even though it is made to last for a long period of time, any of these parts could fail at any time. Therefore, test your alarm warning device at least every half-year according to national codes or laws. Any fire alarm devices or any other components of the system must be repaired and/or replaced immediately as they fail.

This product is not approved to EN54-23 (Beacon Functionality) and must not be used as a visual alarm device or to provide a primary warning notification of fire.